

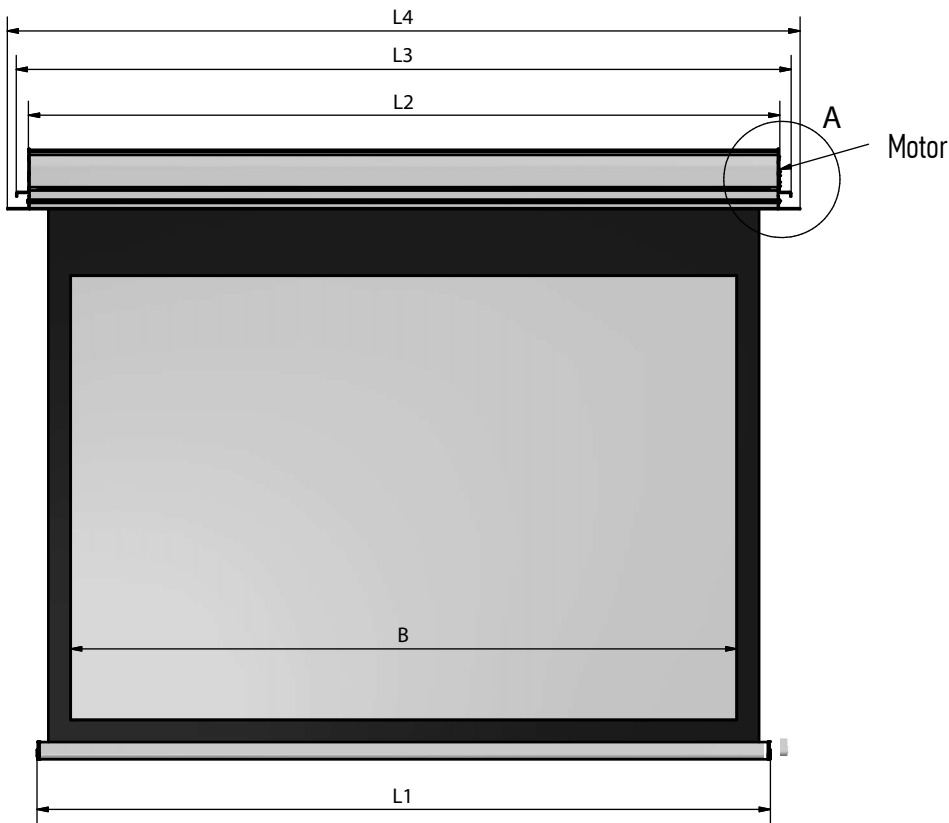

screen  
excellence



Inceiling - Inceiling tensioned



**WARNING!**  
 BEFORE STARTING WITH THE INSTALLATION IN-CEILING, TEST THE FUNCTIONALITY OF THE MOTOR, THE PLANARITY OF THE FABRIC AND GENERALLY CHECK THE PROPER FUNCTIONING OF THE SCREEN.

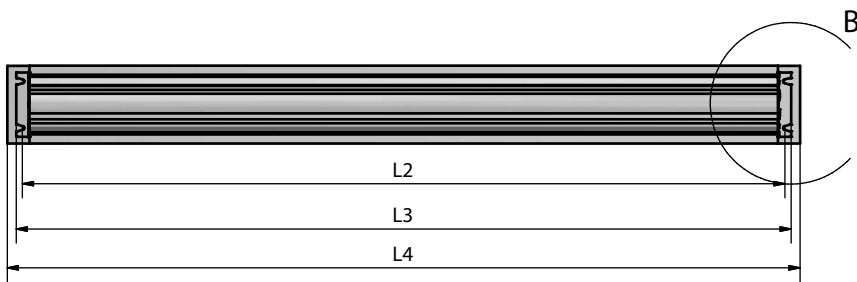

A (1:3)

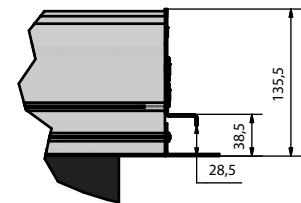

B (1:3)

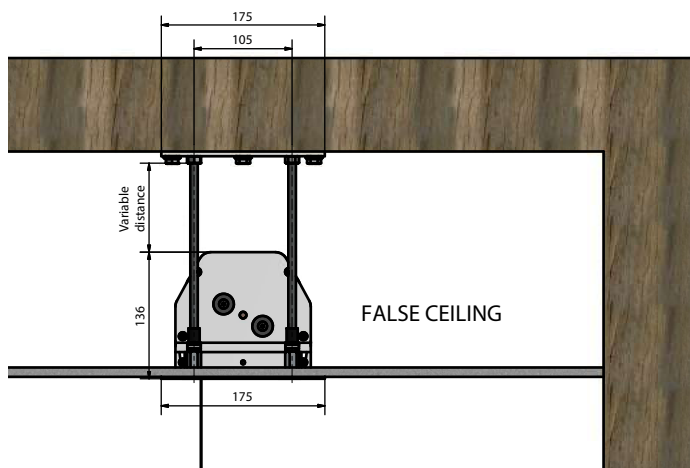
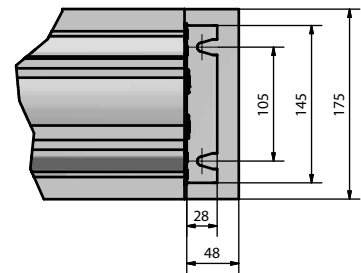

### INCEILING - INCEILING TENSIONED

	DESCRIPTION	WHITE	BLACK BORDERS	WHITE TENSIONED	BLACK TENSIONED
<b>B</b>	PROJECTION BASE				
<b>L1</b>	COUNTERWEIGHT BASE	B+ 40mm	B+ 140mm	B+ 110mm	B+ 215mm
<b>L2</b>	HOLES DISTANCE	B+ 117mm	B+ 217mm	B+ 192mm	B+ 292mm
<b>L3</b>	BRACKETS ENCUMBRANCE	B+ 145mm	B+ 245mm	B+ 220mm	B+ 320mm
<b>L4</b>	TOTAL ENCUMBRANCE	B+ 185mm	B+ 285mm	B+ 260mm	B+ 360mm

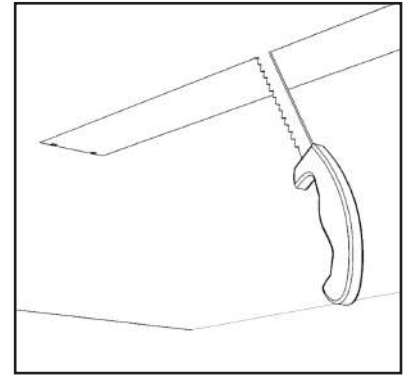
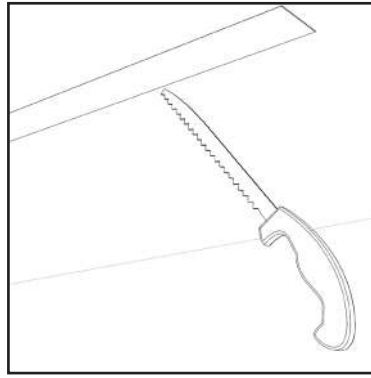
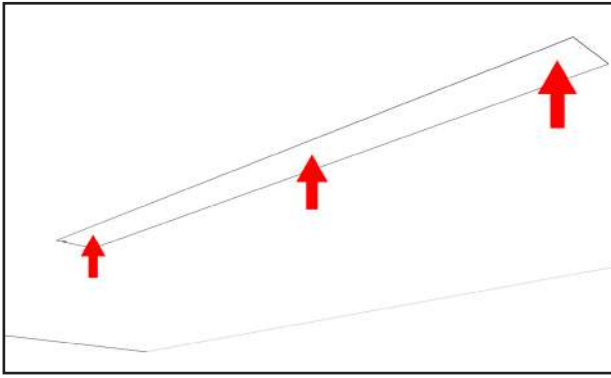

Attach the adhesive stencil to the ceiling in the desired location. Proceed with cutting the false ceiling.

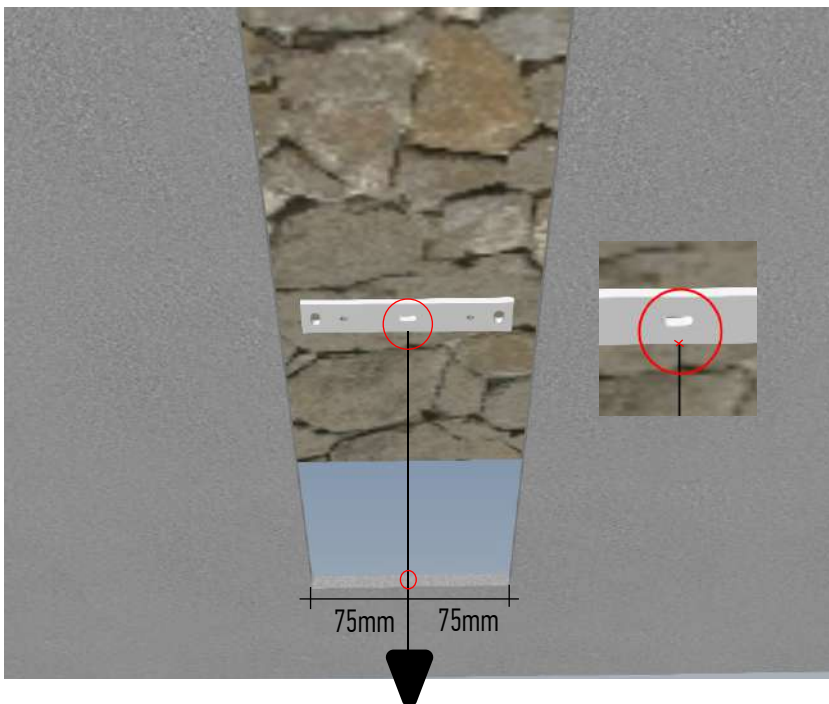
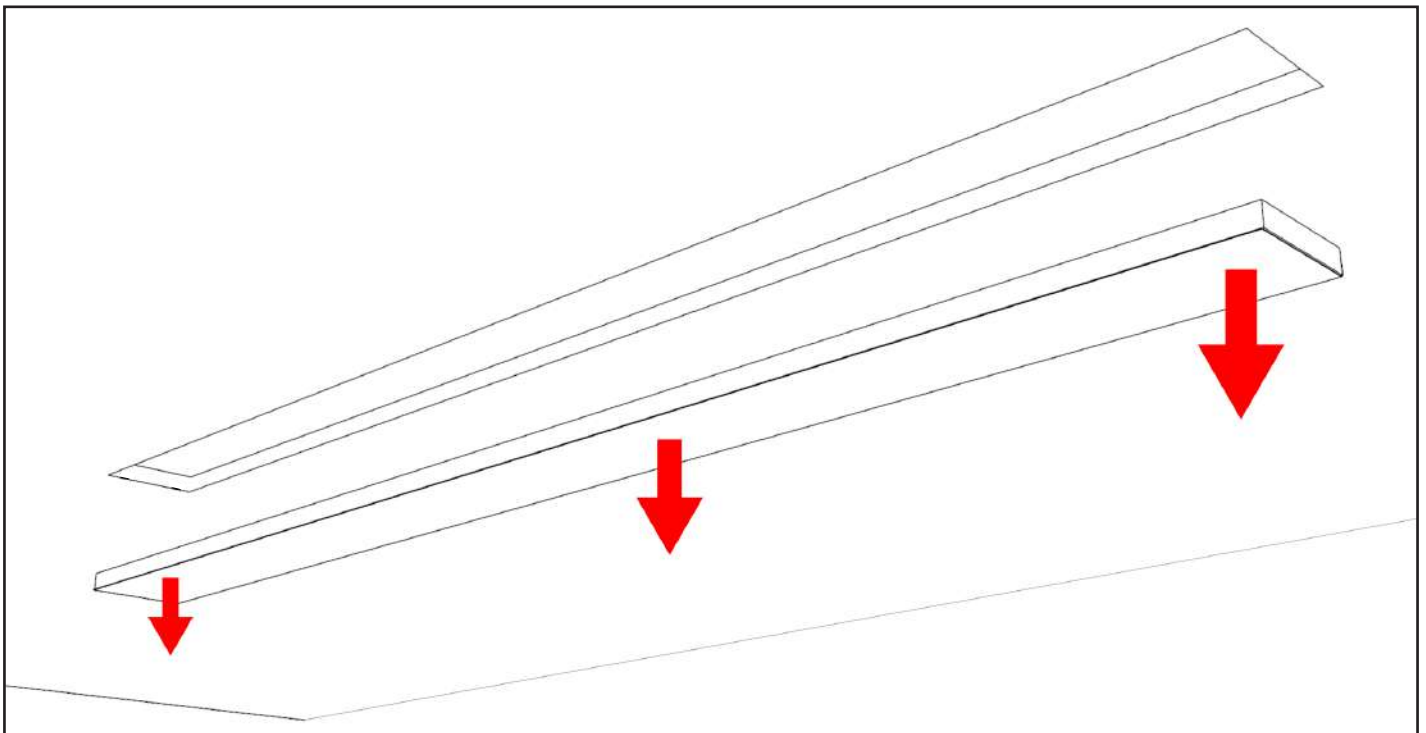

With the help of a laser or a sinker, find the installation point of the brackets. Take the center point of the cut in the ceiling as a reference. 75mm.

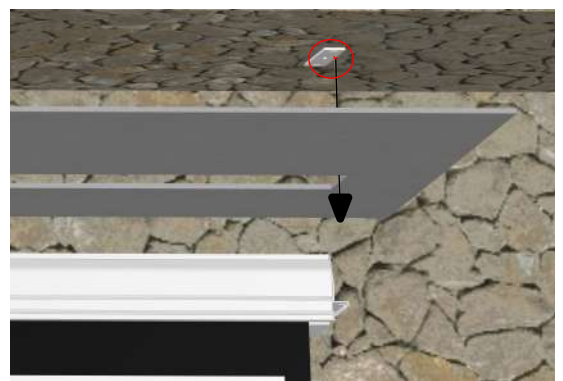

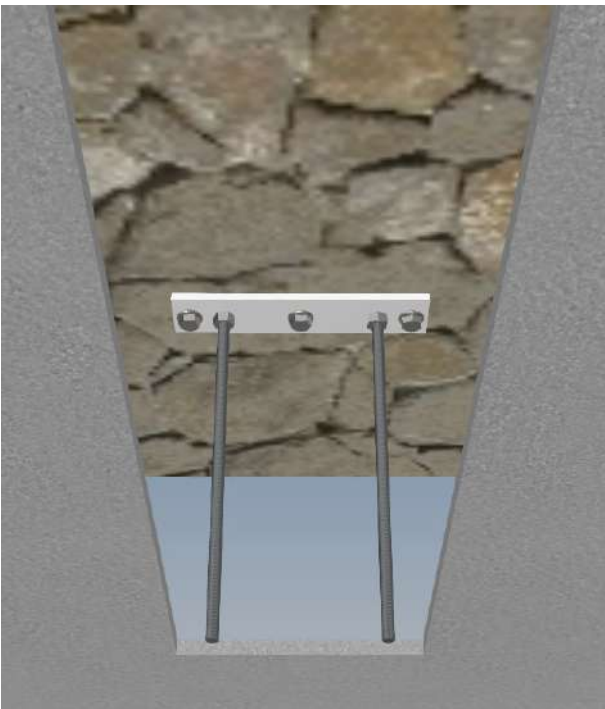

Apply the grommets about 20/25mm from the end of the bars

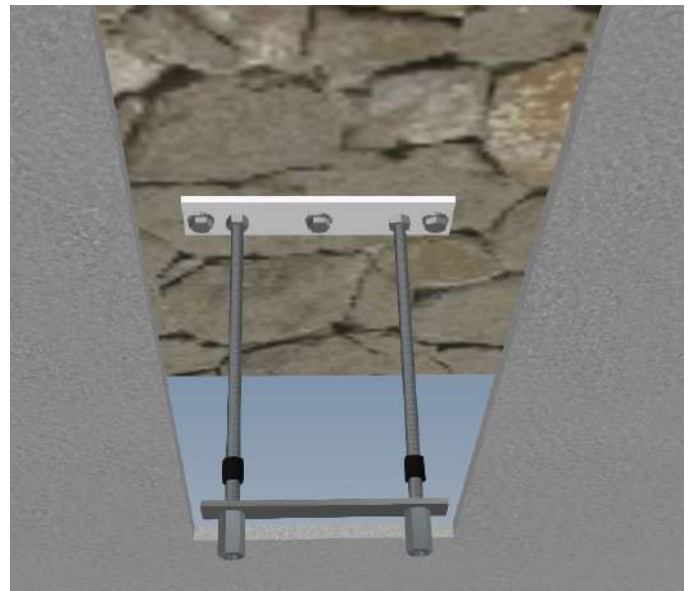

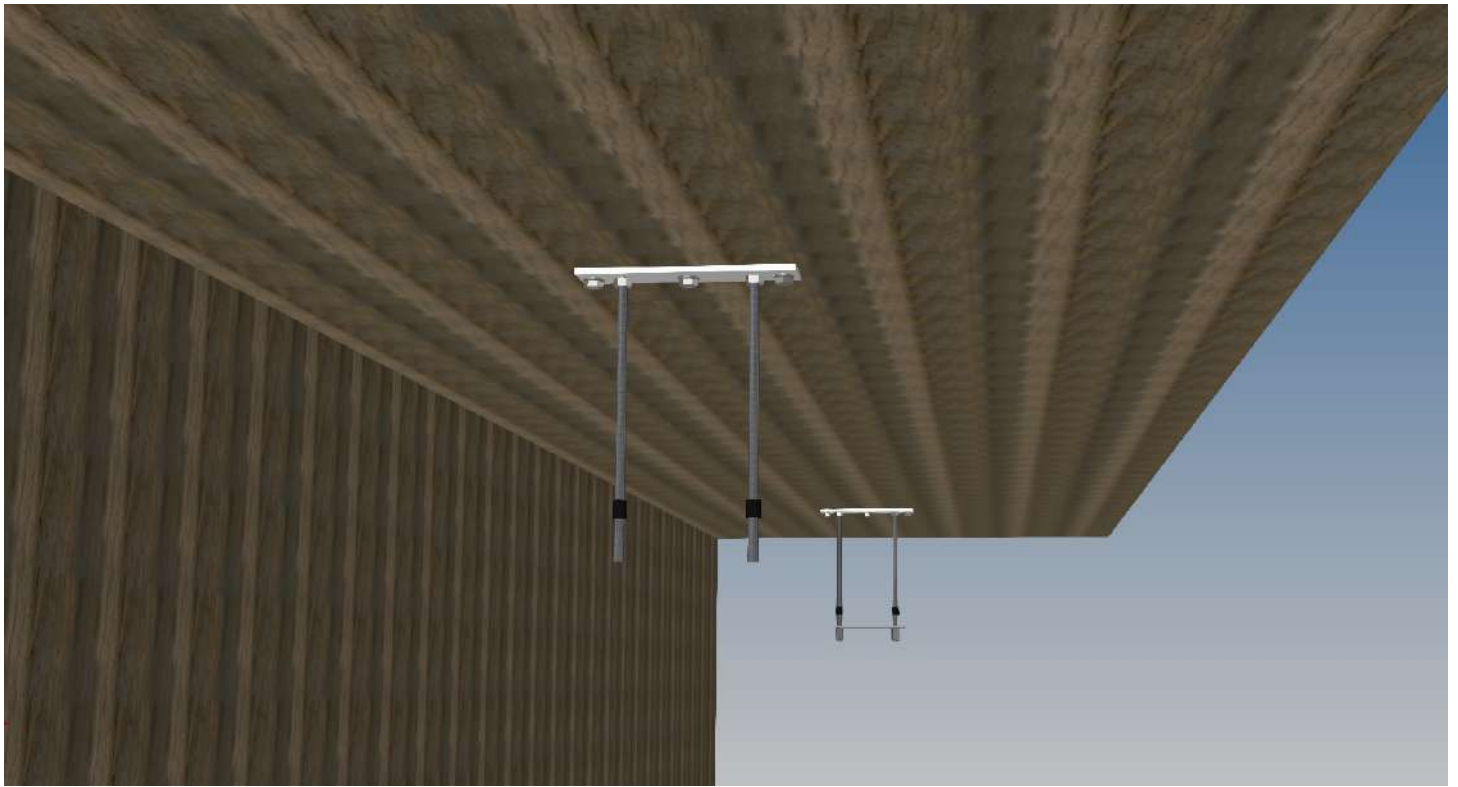

In the other bracket, install only the black rubber pads. Proceed to anchor the screen.

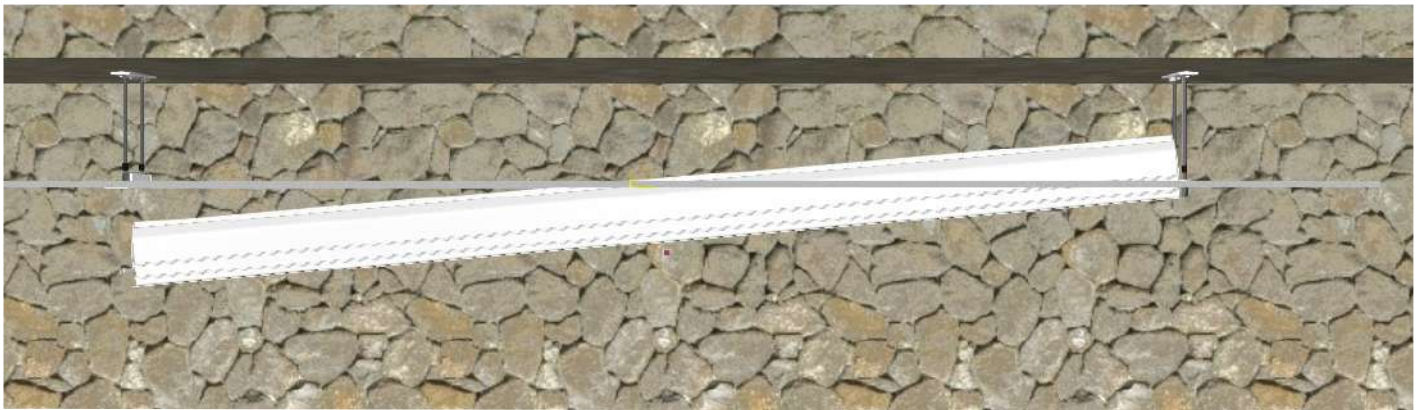

Tilt the screen to help you install.

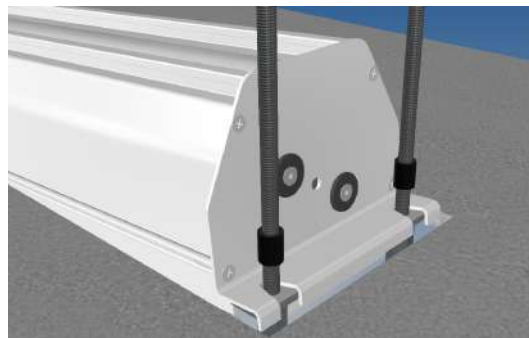
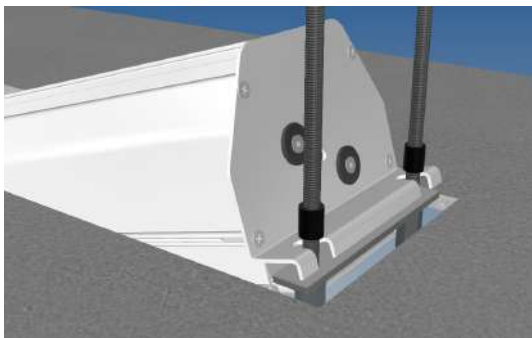

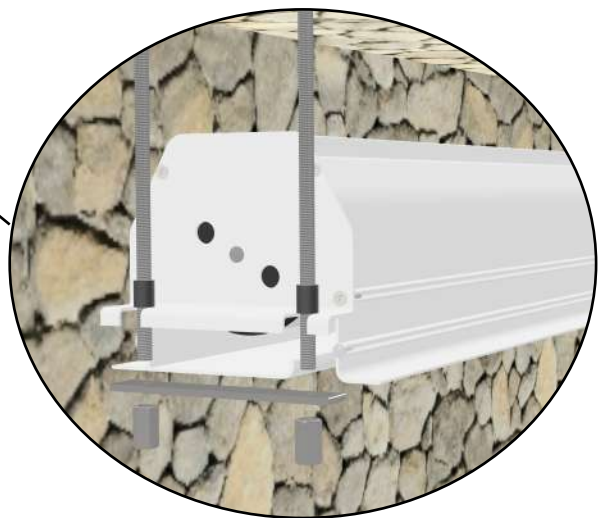
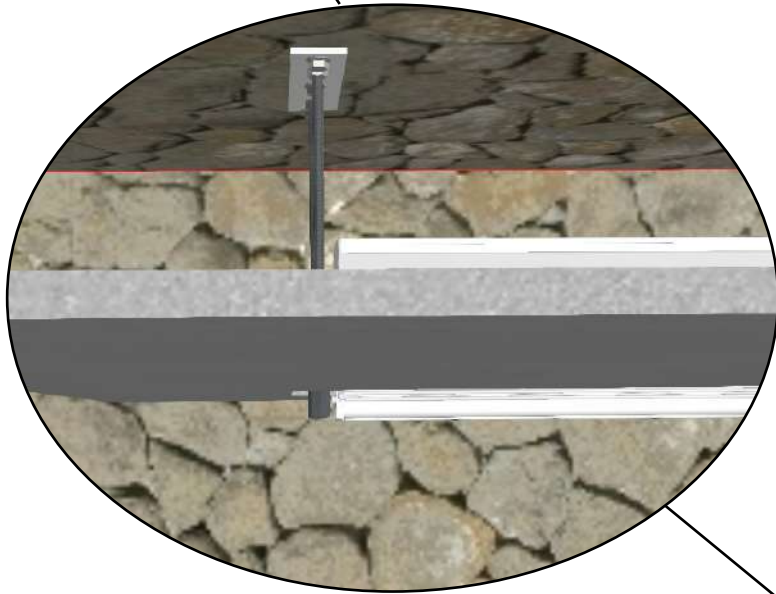

Insert plate and nuts on the second bracket





Screw the nuts so that the screen reaches the correct height at the edge of the false ceiling.

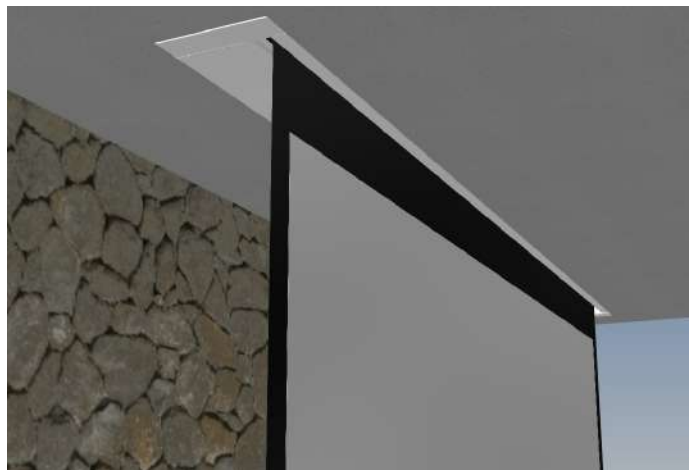
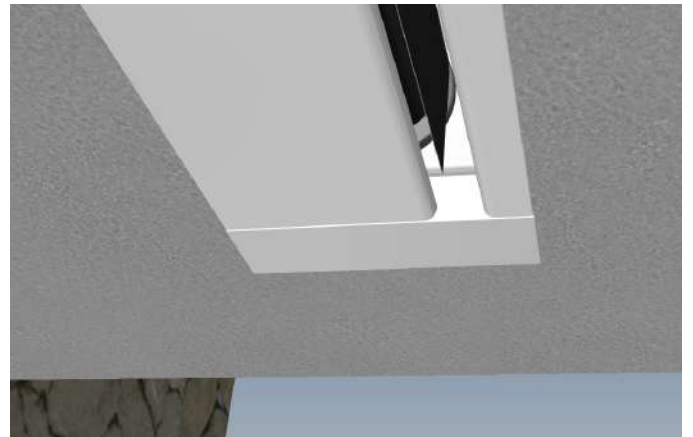
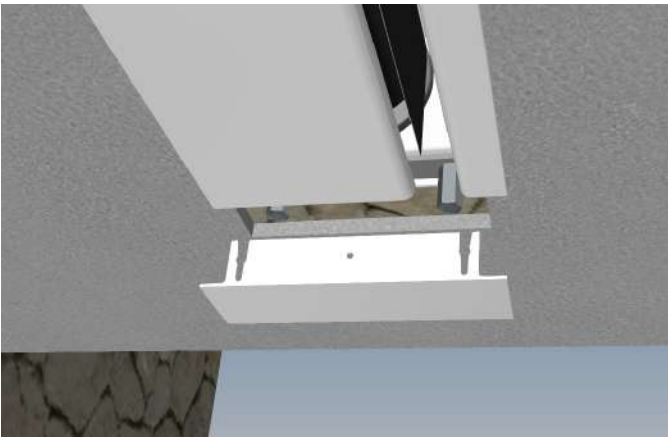

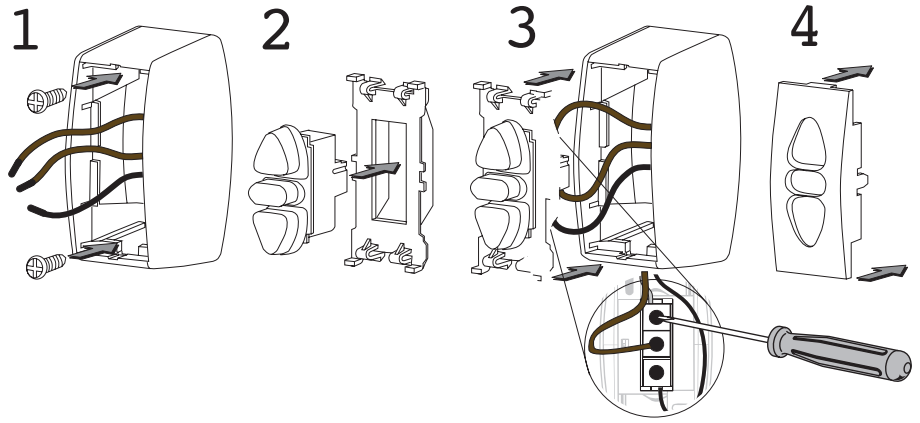
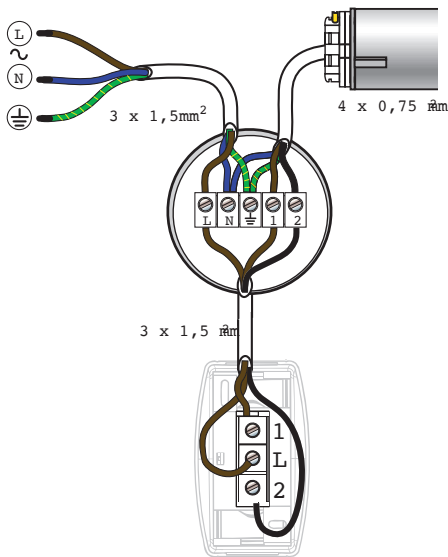

## ITALIANO

MORSETTI	ALIMENTAZIONE	MOTORE (EUR)	MOTORE (US)
L	FASE (L)		
N	NEUTRO (N)	BLU	BIANCO
W	TERRA (W)	GIALLO/VERDE	VERDE
1		NERO O MARRONE	NERO O ROSSO
2		NERO O MARRONE	NERO O ROSSO

- Scollegare l'alimentazione di rete prima dell'intervento.
- Dopo l'installazione non si dovrà esercitare alcuna trazione sulle morsettiere.
- Collegare i fili di terra prima della fase e del neutro.

## ESPAÑOL

CONEXIONES	ALIMENTACIÓN	MOTOR (EUR)	MOTOR (US)
L	FASE (L)		
N	NEUTRO (N)	AZUL	BLANCO
W	TIERRA (W)	AMARILLO/VERDE	VERDE
1		NEGRO O MARRÓN	NEGRO O ROJO
2		NEGRO O MARRÓN	NEGRO O ROJO

- Corte la alimentación de la RED antes de la intervención.
- Después de la instalación, no se debe efectuar ninguna tracción sobre los bornes de conexión.
- Conecte los cables de tierra antes de la fase y el neutro.

## ENGLISH

TERMINALS	POWER SUPPLY	MOTOR (EUR)	MOTOR (US)
L	PHASE (L)		
N	NEUTRAL (N)	BLUE	WHITE
W	EARTH (W)	YELLOW/GREEN	GREEN
1		BLACK OR BROWN	BLACK OR RED
2		BLACK OR BROWN	BLACK OR RED

- Disconnect the main supply before carrying out any work.
- Ensure that no forces act on terminals after installation.
- Connect the earth wires before phase and neutral.

## عربي

طرف التلامس	التغذية الكهربائية	محرك (EUR)	محرك (US)
L	خط طور (L)		
N	خط بارد (N)	أزرق	أبيض
W	خط أرضي (W)	أصفر/أخضر	أخضر
1		أسود أو بني	أسود أو أحمر
2		أسود أو بني	أسود أو أحمر

- إفضل الكهرباء (خط طور) قبل التوصيل.
- عدم سحب الأسلاك (عند نقط التوصيل) بعد التوصيل.
- يجب توصيل الخط الأرضي قبل خط طور والبارد.

## FRANCAIS

BORNES	ALIMENTATION	MOTEUR (EUR)	MOTEUR (US)
L	PHASE (L)		
N	NEUTRE (N)	BLEU	BLANC
W	TERRE (W)	JAUNE/VERT	VERT
1		NOIR OU MARRON	NOIR OU ROUGE
2		NOIR OU MARRON	NOIR OU ROUGE

- coupez l'alimentation secteur avant l'intervention.
- après l'installation, aucune traction ne doit s'exercer sur les borniers.
- branchez les fils de terre avant la phase et le neutre.

## 中文

接线端	电源	电机 (欧洲)	电机 (美国)
L	相线 (L)		
N	中线 (N)	蓝色	白色
W	地线 (W)	黄色/绿色	绿色
1		黑色或褐色	黑色或红色
2		黑色或褐色	黑色或红色

- 操作前，先切断该区域的电源。
- 安装后，不可再拉牵接线柱。
- 地线须在相线和中线之前插上。

## DEUTSCH

KLEMMEN	NETZ	ANTRIEB (EUR)	ANTRIEB (US)
L	PHASE (L)		
N	NULLPUNKT (N)	BLAU	WEISS
W	ERDUNG (W)	GELB GRÜN	GRÜN
1		BRAUN O. SCHWARZ	ROTO. SCHWARZ
2		BRAUN O. SCHWARZ	ROTO. BRAUN

- Vor Durchführung der Arbeiten Netzanschluss freischalten, und gegen unbeabsichtigtes Einschalten sichern.
- Nach der Installation darf kein Zug auf die Klemmen entstehen.
- Zuerst Schutzleiter erst dann Phase und Mittelleiter anschließen.

## РУССКИЙ

ЗАЖИМЫ	СЕТЬ	ПРИВОД (Европа)	ПРИВОД (США)
L	ФАЗА (L)		
N	НЕЙТРАЛЬ (N)	СИНИЙ	БЕЛЫЙ
W	ЗЕМЛЯ (W)	ЖЕЛТО-ЗЕЛЕНЫЙ	ЗЕЛЕНЫЙ
1		ЧЕРН. ИЛИ КОРИЧН.	ЧЕРН. ИЛИ КОРИЧН.
2		ЧЕРН. ИЛИ КОРИЧН.	ЧЕРН. ИЛИ КОРИЧН.

- Работы выполнять только при отключенной сети.
- После монтажа провода не должны действовать на зажимы втяг.
- Вначале подсоединить провод заземления, затем