



SLIM

Fixed Frame Projection Screen

ASSEMBLY INSTRUCTIONS



Caution: preliminary notice

Assembling this screen and installing it requires some professional know how. You will need 2 persons, as the screen is too heavy and bulky to be handled by a single person. You will need to be able to evaluate a totally safe way to fix the provided brackets to the wall where it is to be installed, and to provide it. It can be rubber, steel or plastic wall plugs, or hollow wall anchors.

SLIM COMPONENTS LIST

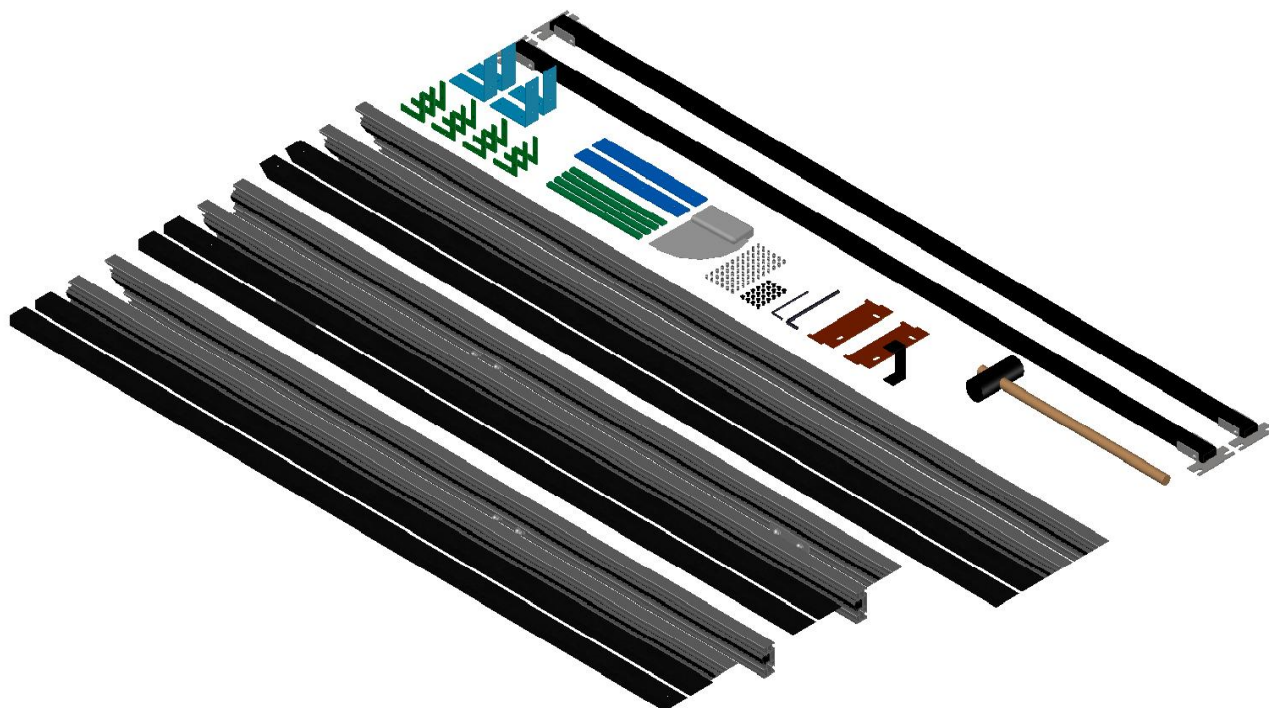

1. Top main frame – qty 2 x ½ (screens 90” and under – qty 1)
2. Bottom main frame – qty 2 x ½ (screens 90” and under – qty 1)
3. Vertical main frame – qty 2
4. Decorative frame top – qty 2 x ½ (screens 90” and under – qty 1)
5. Decorative frame bottom – qty 2 x ½ (screens 90” and under – qty 1)
6. Decorative frame vertical – qty 2
7. Stiffening bar with stiffening heads – qty 2
8. Main angle brackets – qty 16
9. Main prolongators – qty 2 (screens 90” and under – qty 0)
10. Deco angle bracket – qty 4
11. Deco prolongators – qty 2 (screens 90” and under – qty 0)
12. Wall brackets – qty 2 couples
13. Middle clip
14. Spatula
15. Mallet – for p-grip usage
16. M4 headless screws – qty 66 (screens 90” and under – qty 48)
17. M4 countersink screws – qty 24 (screens 90” and under – qty 16)
18. Allen key 2mm and 4mm
19. Pair of glass and protective dust sheet

You will also need the following:

Tape measure, Spirit level, Sharp scissors, Screws and wall plugs,



Assembly advice

Clear a space sufficiently larger than the external dimensions of the screen with access to all sides – ideally this should be a clean, flat surface to protect the screen from damage.

Carefully remove of the components from box and check them against list. Locate the plastic sheet and spread it out onto your clean assembly surface. Several component joints are colour coded with round coloured stickers.

PLEASE RESPECT THE COLOUR CODING.

Your screen has been pre-assembled in factory and the colour coding is important.

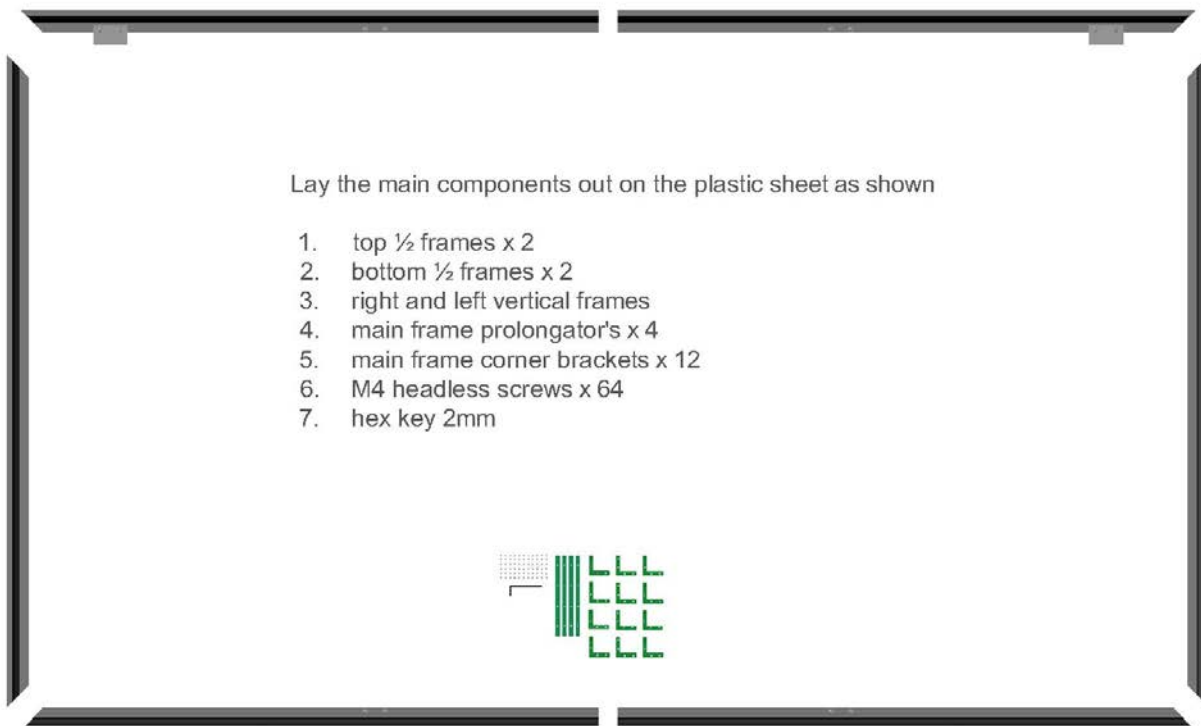

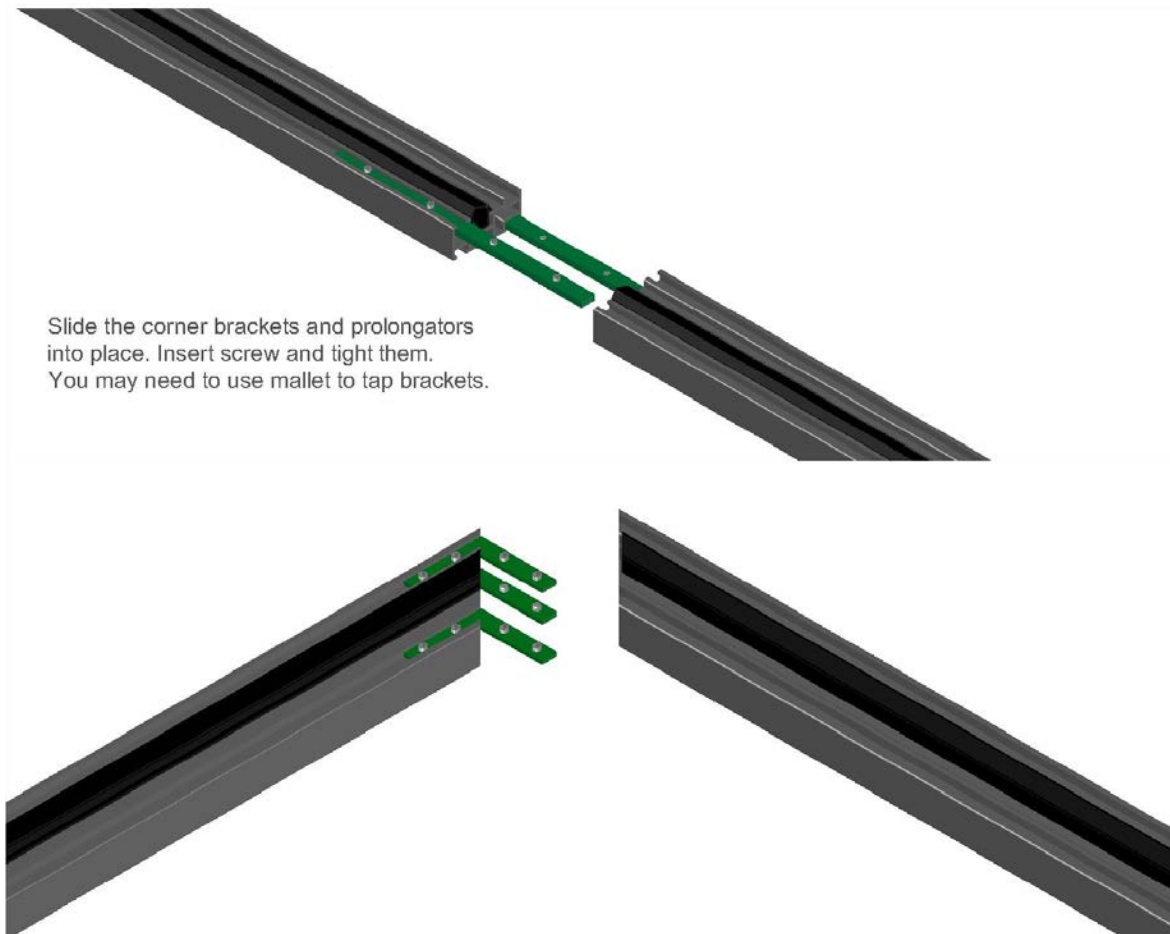

NOTE:

SLIM 90" and under don't need to use prolongators.

Instead it has 4 pieces of frame: 1 top, 1 bottom and 2 sides.

Tight all screw. Screen main frame is assembled.
Wall brackets are fitted to frame. Picture show the screen
from behind before the fabric is fitted.

You can see longer wall bracket which need to
be placed on wall.

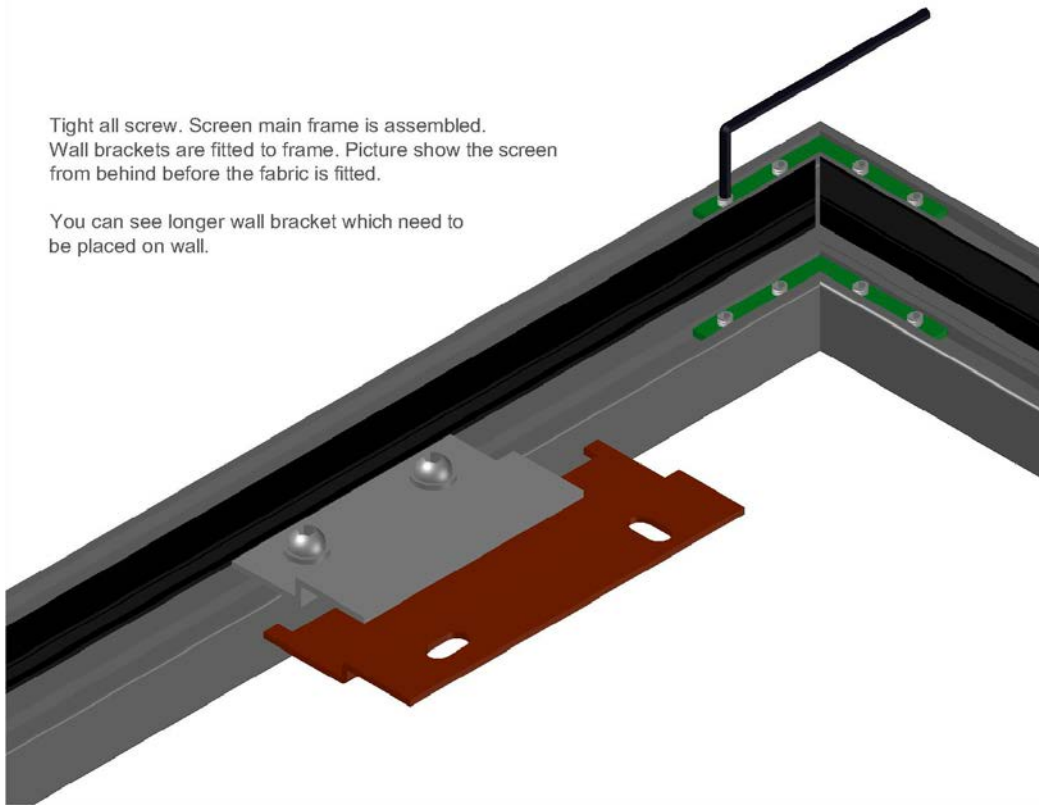

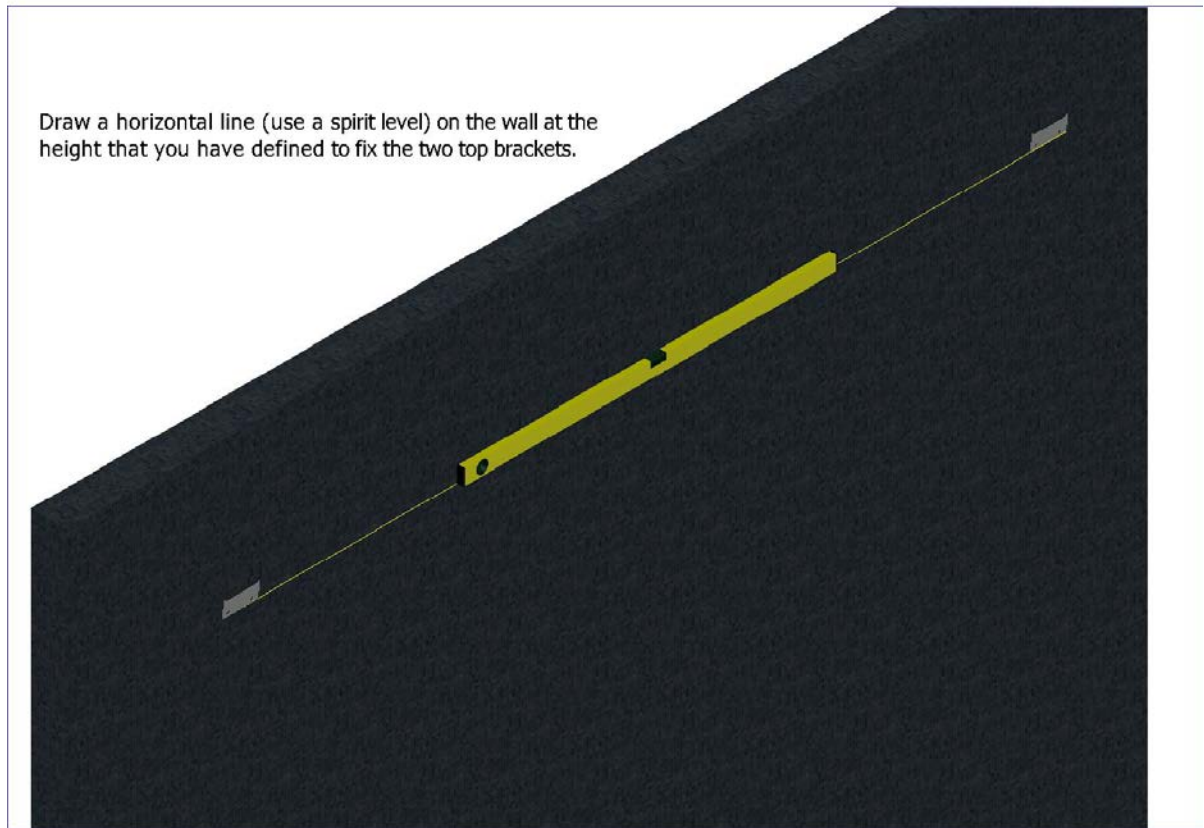

Determine the positions of the wall screws ($\frac{1}{4}$ " or 6mm). The lateral position of frame brackets can be changed by loosening the retaining screws and the brackets to the required position.

Use wall plugs of suitable size and strength for screen. The vertical position of the brackets can be determined from picture.

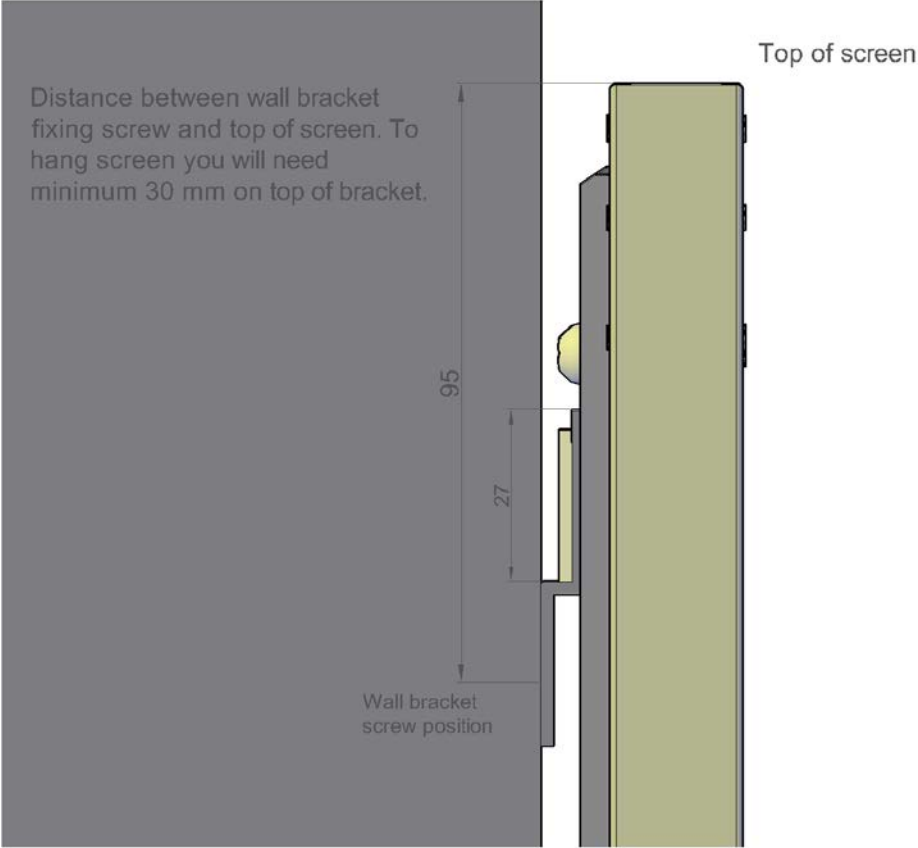

After mounting stiffening bars, main frame is ready.

Set the finished frame aside and now unfold the black backing fabric and lay it flat on the plastic foil.

ENSURE THAT THE PLASTIC FOIL IS CLEAN AND FLAT - IT IS ALSO WORTH WASHING YOUR HANDS AT THIS POINT TO ENSURE THAT THE FABRICS ARE KEPT AS CLEAN AS POSSIBLE.

Lay the finished screen frame on top of the black fabric with the front face of the frame down, touching the black fabric as shown below. It is important that the fabric is as smooth and wrinkle free as possible.

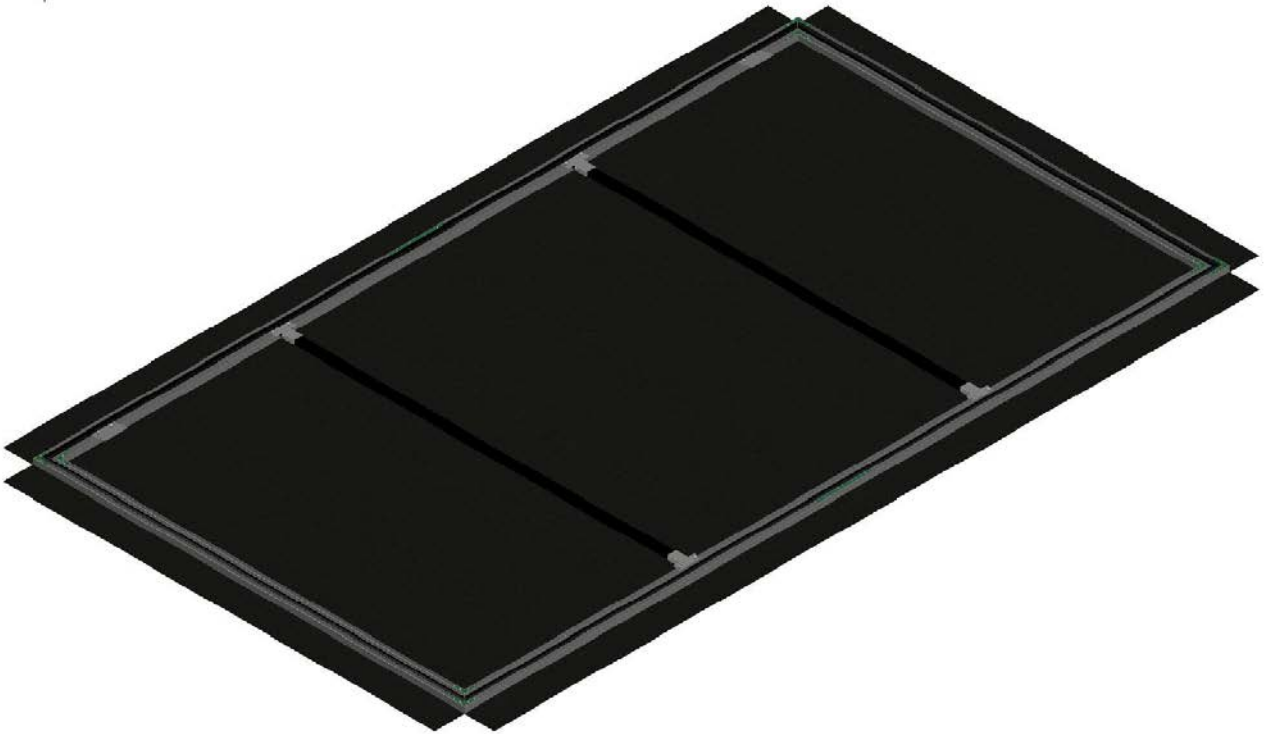

Starting from one end, fold the black fabric around the frame as shown carefully folding the corners and ensuring that the fabric is smooth and wrinkle free.

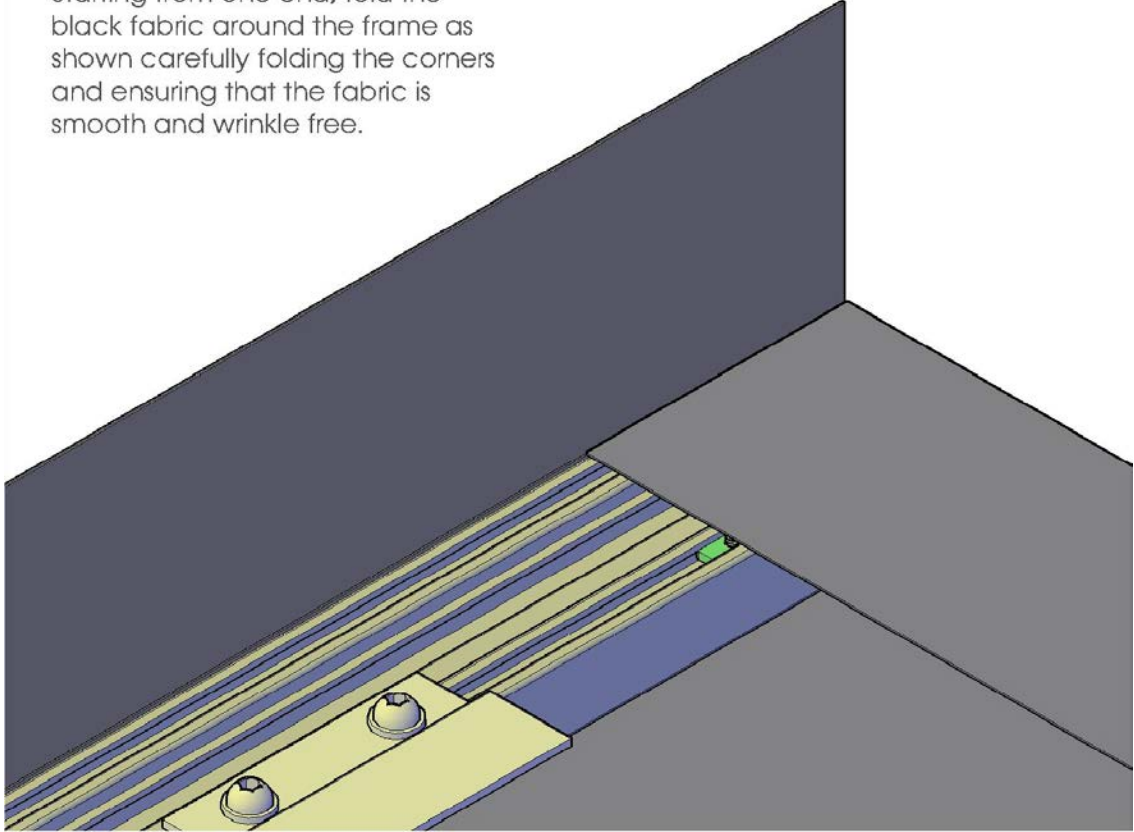

Black fabric installation using p-grip

Place provided pi-grip/grip-fix on fabric laying on frame. Using supplied mallet, insert the Black Backing into the groove on the rear face of the frame, trapping the fabric in the groove. The action of pushing the fabric will tension it. Again, ensure that the fabric is smooth and wrinkle free. Do it around frame.

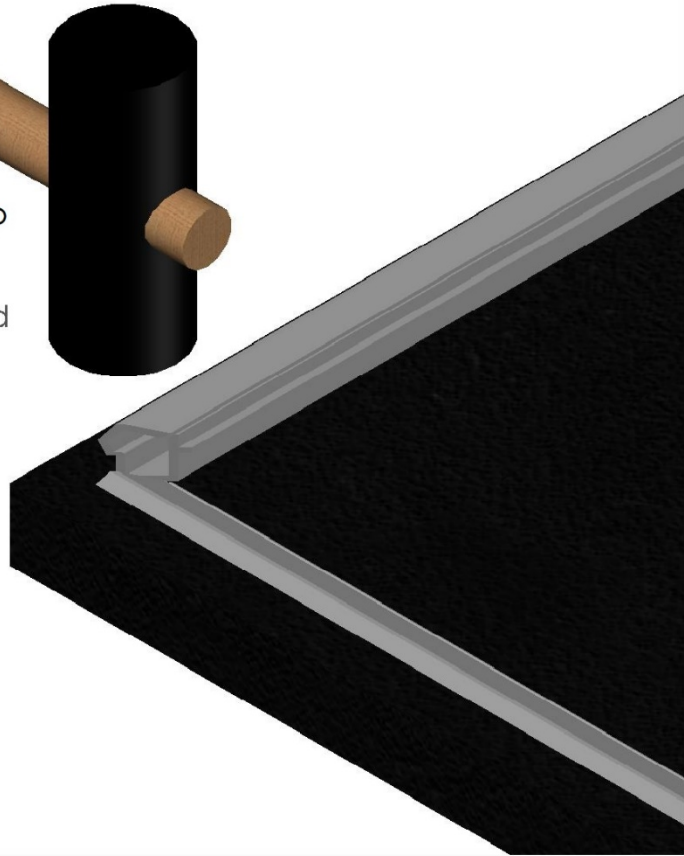

NOTE:

If your screen using grip-fix profile as in the picture on the right, then skip this page and follow the instructions on next page.

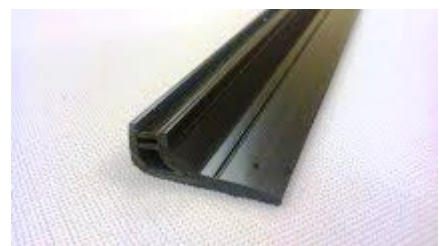

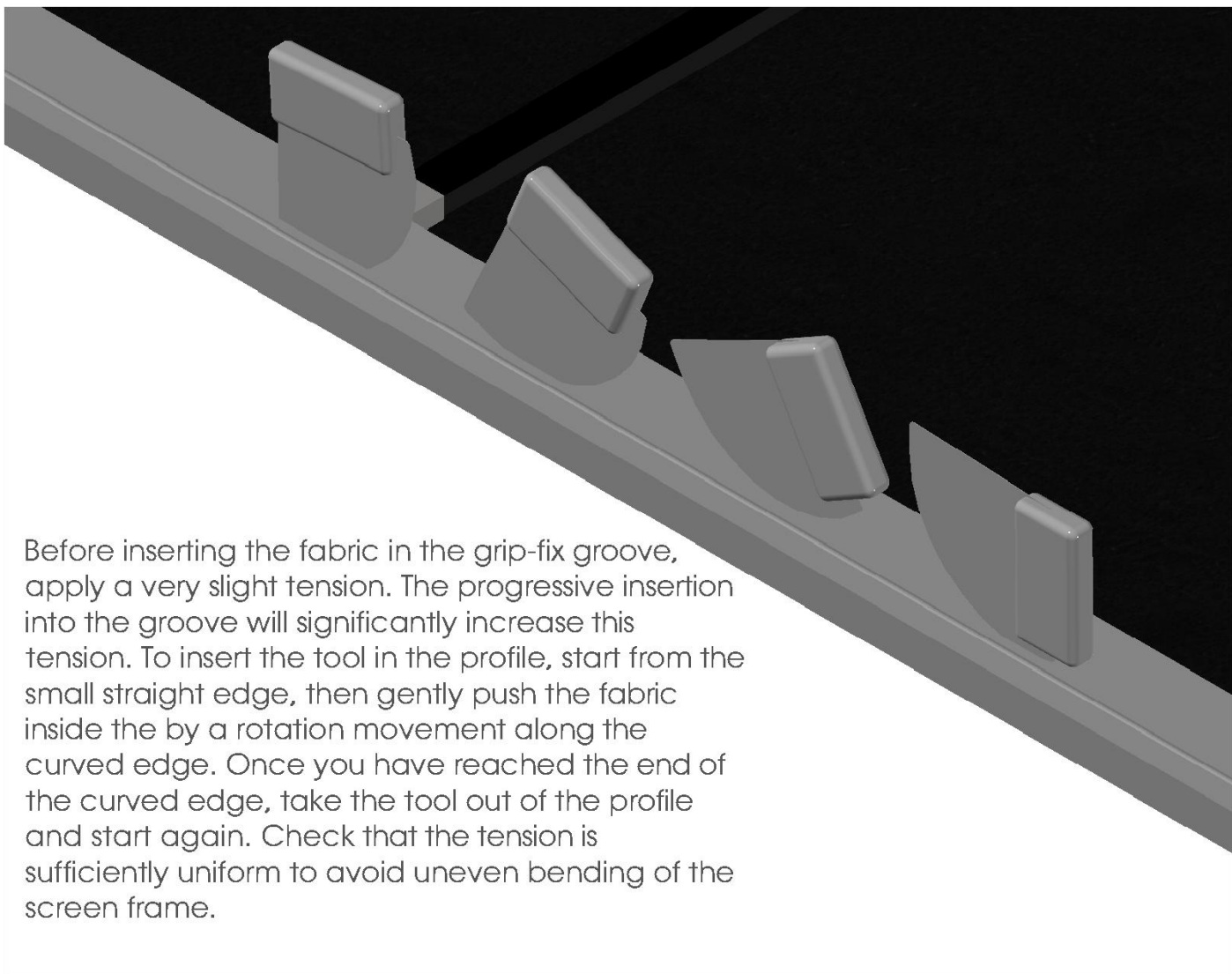

To insert white fabric, use these same techniques like for grip-fix (upper picture).

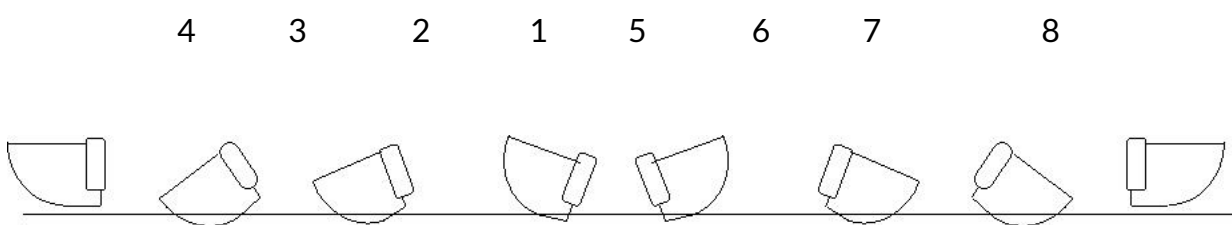

Using prolongators and provided screws join two ½ frames to create top decorative frame and then two ½ frames to create bottom decorative frame.

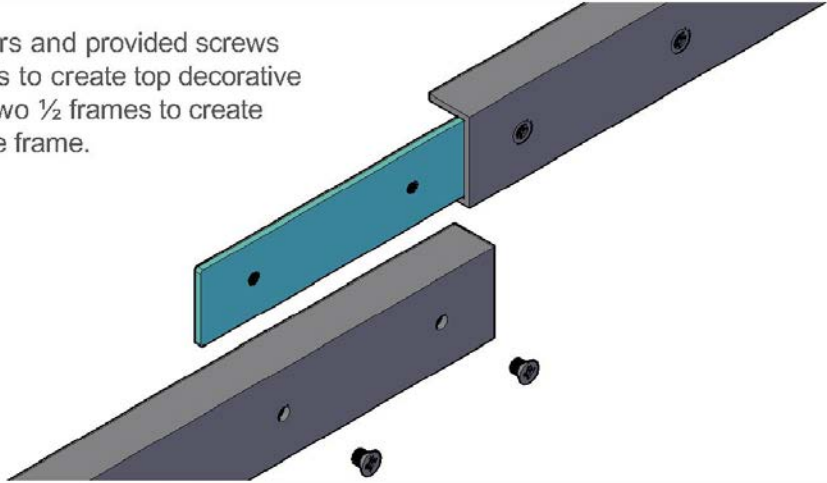

NOTE: Do not tight screws before whole decorative frame is set around the screen.

Fix 2 angle brackets to each vertical decorative frame.

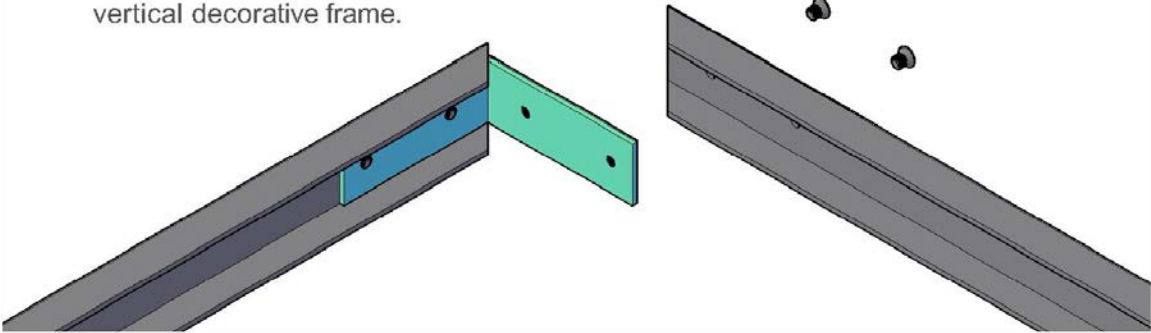

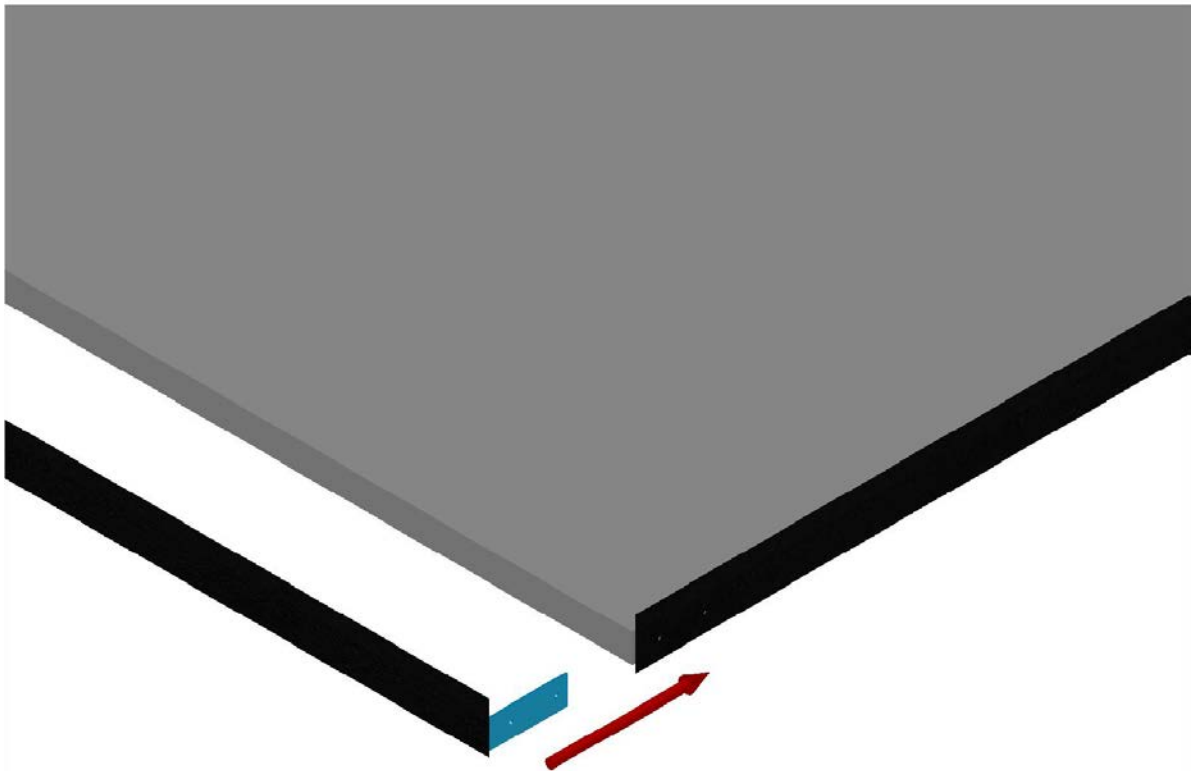

Place decorative frame around screen, slide vertical parts in to horizontal top and bottom and tight all screws.

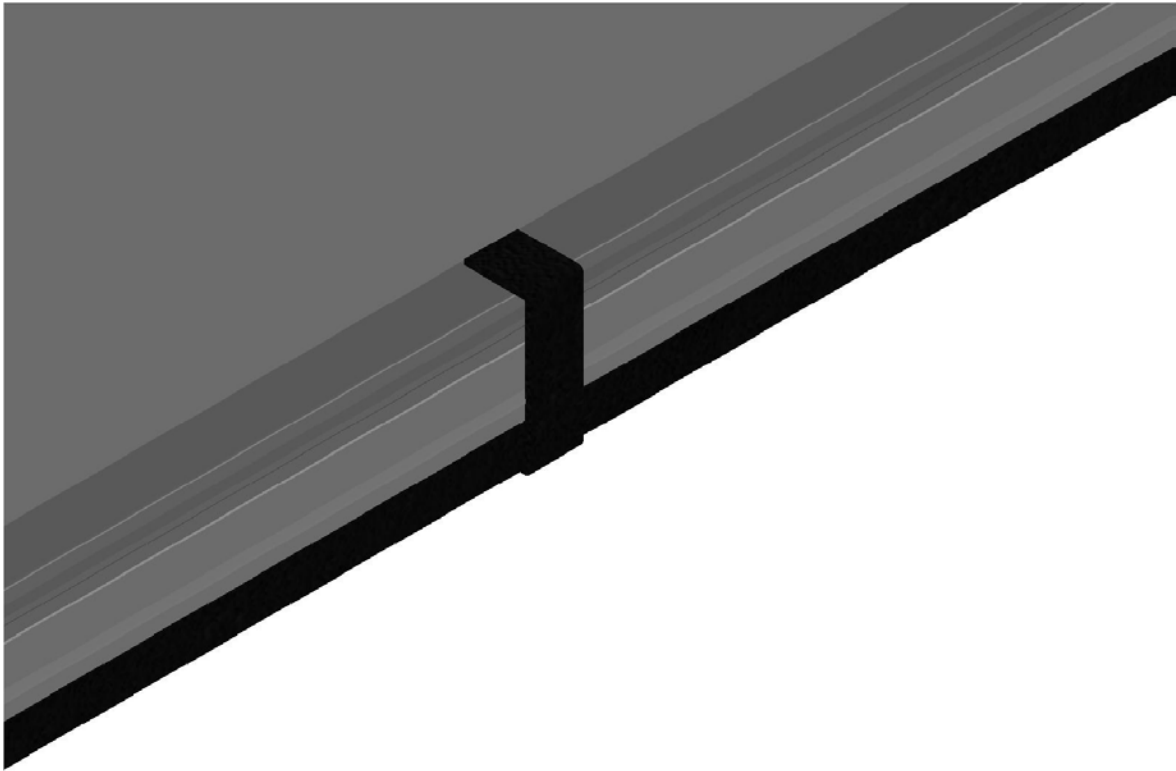

Fix the middle bracket of the external frame to the main frame (is push on)

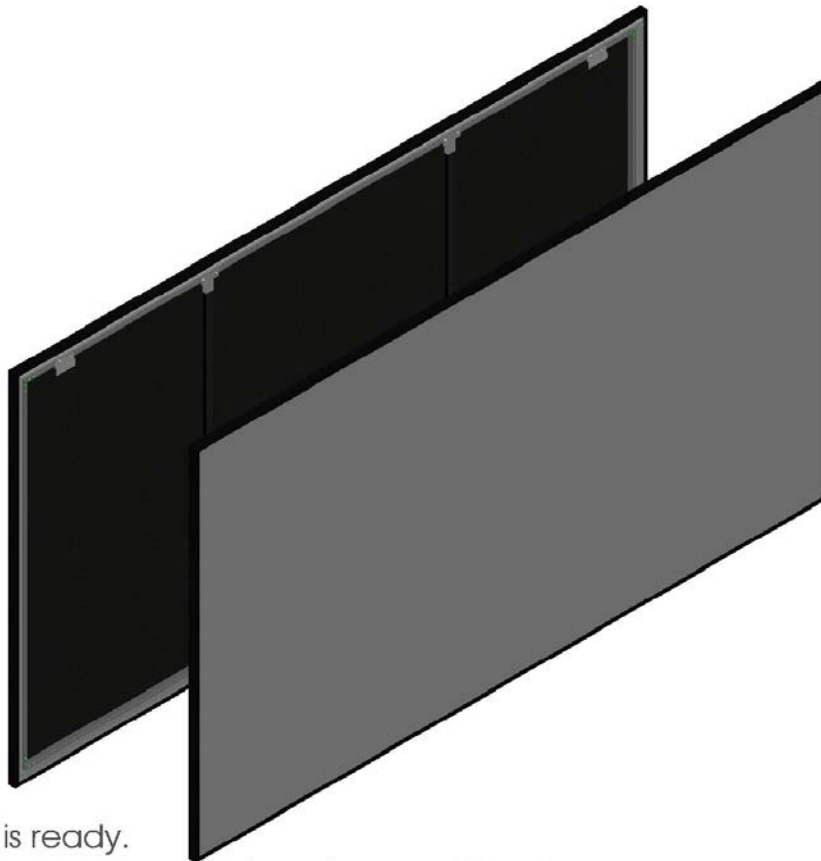

Screen is ready.
View represent screen from front and back.

With at least one other person, lift the screen and hang into place. There is some lateral movement available in the brackets allow positional adjustment to be made.

The screen installation is finished.